

Professional LED Light System  
for Medical Surgery



# LUVIS L200 USER'S MANUAL

---



**Major Surgical Luminaire**

**DENTIS CO., LTD.**

**87, Yuram-ro, Dong-gu, Daegu, Republic of Korea**

Tel. +82-53-583-2804, FAX. +82-53-583-2806 [www.dentis.co.kr](http://www.dentis.co.kr) / [www.luviz.co.kr](http://www.luviz.co.kr)

## CONTENTS

1. Standards .....	4
2. Cautions and Warnings .....	5
3. Symbol(Symbole).....	11
4. Introduction .....	13
4.1 Intended use .....	13
4.2 General description .....	14
4.3 Environmental requirement.....	15
4.4 Safety information .....	15
4.5 Warranty regulation .....	16
4.6 Electromagnetic Compatibility .....	17
5. LIGHTHEAD specification.....	19
5.1 Technical specification (In accordance with EN/IEC 60601-2-41) .....	19
5.2 Electrical specification (In accordance with EN/IEC 60601-1) .....	20
5.3 Mechanical specification .....	21
5.4 Configuration of SPRING ARM & LIGHTHEAD .....	22
5.5 Configuration of SPRING ARM & Specific options .....	23
5.6 Internal Camera(optional) specification .....	23
5.7 Other characteristic.....	23
6. USE.....	24
6.1 ARM CONTROLLER.....	24
6.2 HANDLE TOUCH CONTROLLER.....	25
6.3 CAMERA TOUCH CONTROLLER(optional) .....	26
6.4 WALL CONTROL BOX(optional).....	27

6.5 Controlling the INTERNAL CAMERA(optional) ..... 28

6.6 Positioning ..... 29

6.7 MAIN HANDLE ..... 30

6.8 Mobile Type..... 31

6.9 BATTERY PACK..... 32

7. Performance characteristic..... 33

    7.1 LIGHTHEAD on the SPRING ARM ..... 33

8. Cleaning and Sterilization ..... 34

    8.1 Cleaning the equipment..... 34

    8.2 MAIN HANDLE AUTOMATIC CLEANING ..... 35

    8.3 MAIN HANDLE MANUAL CLEANING..... 35

    8.4 Sterilization(MAIN HANDLE, CAMERA COVER & CAMERA SEALING)..... 36

9. Maintenance ..... 37

10. Troubleshooting..... 38

11. Disposal..... 40

12. Model designation ..... 40

13. List of component ..... 41

14. Manufacturer and Factory ..... 44

15. Europe Representative..... 45



**“WARNING: Modification of this equipment is not allowed”**

## 1. Standards

- Certification of DENTIS
  - EN ISO 13485:2016
  - Relevant EC Regulation: REGULATION (EU) 2017/745
- Applied Standards:
  - EN ISO 15223-1:2016, Medical devices – Symbols to be used with medical device labels, labelling and information to be supplied – Part 1: General requirements
  - EN 1041:2008/A1:2013, Information supplied by the manufacturer with medical devices
  - EN ISO 13485:2016, Medical devices – Quality management systems – Requirements for regulatory purpose
  - EN ISO 14971:2019, Medical devices – Application of risk management to medical devices
  - EN 60601-1:2006+A2:2021, Medical electrical equipment – Part 1: General requirements for basic safety and essential performance
  - EN 60601-1-2:2015, Medical electrical equipment – Part 1-2: General requirements for basic safety and essential performance - Collateral standard: Electromagnetic disturbances – Requirements and tests
  - EN 60601-1-6:2010, Medical electrical equipment-Part 1-6: General requirements for basic safety and essential performance – Collateral Standard: Usability
  - EN ISO 7010:2019, Graphical symbols – Safety colors and safety signs-Registered safety signs
  - EN 62471:2008, Photo biological safety of lamps and lamps systems
  - EN 62366-1:2015, Medical devices – Application of usability engineering to medical devices
  - IEC 60601-2-41:2009/A1:2015, Medical electrical equipment – Part 2-41: Particular requirements for the basic safety and essential performance of surgical luminaires and luminaires for diagnosis
  - IEC 62133:2012, Secondary cells and batteries containing alkaline or other non-acid electrolytes – Safety requirements for portable sealed secondary cells, and for batteries made from them, for use in portable applications
  - IEC 62304:2006/A1:2015, Medical device software, Software life-cycle processes

## 2. Cautions and Warnings



### CAUTION(ATTENTION)

This ME Equipment is intended only for use in the professional healthcare facility environment, e.g. public and private hospitals, specialized medical offices, etc. This ME Equipment is intended for direct use on operation theatres and nearby HF surgical equipments, where the intensity of EM DISTURBANCES complies with the applicable standards. For further instructions please follow the chapter "Electromagnetic compatibility" of the User's Manual.

- Cet équipement ME est destiné uniquement à être utilisé dans l'environnement des établissements de santé professionnels, p. ex. hôpitaux publics et privés, cabinets médicaux spécialisés, etc. Cet équipement ME est destiné à être utilisé directement sur les salles d'opération et les équipements chirurgicaux HF situés à proximité, où l'intensité des perturbations électromagnétiques est conforme aux normes applicables. Pour de plus amples instructions, veuillez suivre le chapitre « Compatibilité électromagnétique » du Manuel de l'utilisateur.



### CAUTION(ATTENTION)

If this ME Equipment is lost or degraded the performance due to EM DISTURBANCES, result in improper operation and degradation of the performance.

- Si cet équipement est perdu ou dégradé en raison de perturbations électromagnétiques, il en résulte un mauvais fonctionnement et une dégradation de la performance.



### CAUTION(ATTENTION)

All cables and maximum lengths of coaxial cables that are replaceable by the DENTIS and that are likely to affect compliance of the this ME Equipment with the requirements of EMC(Electro-Magnetic Compatibility).

Do not modify this ME Equipment.

- Tous les câbles et longueurs maximales des câbles coaxiaux remplaçables par DENTIS et susceptibles d'affecter la conformité de cet ÉQUIPEMENT ME aux exigences de la CEM (Compatibilité Électro-Magnétique).

Ne modifiez pas cet ÉQUIPEMENT ME.

**CAUTION(ATTENTION)**

The EMISSIONS characteristics of this equipment make it suitable for use in industrial areas and hospitals (CISPR 11 Class A). If it is used in a residential environment (for which CISPR 11 Class B is normally required) this equipment might not offer adequate protection to radio-frequency communication services. The user might need to take mitigation measures, such as relocating or re-orienting the equipment.

- Les caractéristiques d'ÉMISSIONS de cet équipement le rendent adapté à une utilisation dans des zones industrielles et des hôpitaux (CISPR 11 classe A). S'il est utilisé dans un environnement résidentiel (où la classe B CISPR 11 est normalement requise), cet équipement pourrait ne pas offrir une protection adéquate aux services de communication radiofréquence. L'utilisateur pourrait devoir prendre des mesures d'atténuation, telles que déplacer ou réorienter l'équipement.

**WARNING(AVERTISSEMENT)**

Use of this ME Equipment adjacent to or stacked with other equipment should be avoided because it could result in improper operation. If such use is necessary, this equipment and the other equipment should be observed to verify that they are operating normally.

- L'utilisation de cet ÉQUIPEMENT ME à proximité ou empilé avec d'autres équipements doit être évitée car cela pourrait entraîner un fonctionnement incorrect. Si une telle utilisation est nécessaire, cet équipement et les autres équipements doivent être surveillés pour vérifier qu'ils fonctionnent normalement.

**WARNING(AVERTISSEMENT)**

Use of accessories, transducers and cables other than those specified or provided by DENTIS of this ME Equipment could result in increased electromagnetic emissions or decreased electromagnetic immunity of this equipment and result in improper operation.

- L'utilisation d'accessoires, de transducteurs et de câbles autres que ceux spécifiés ou fournis par DENTIS pour cet ÉQUIPEMENT ME pourrait entraîner une augmentation des émissions électromagnétiques ou une diminution de l'immunité électromagnétique de cet équipement, et entraîner un fonctionnement incorrect.

**WARNING(AVERTISSEMENT)**

Portable RF communications equipment (including peripherals such as antenna cables and external antennas) should be used no closer than 30 cm(12 inches) to any part of the L200, including cables specified by DENTIS. Otherwise, degradation of the performance of this equipment could result.

- Les équipements de communication RF portables (y compris les périphériques tels que les câbles d'antenne et les antennes externes) ne doivent pas être utilisés à moins de 30 cm (12 pouces) de toute partie du L200, y compris les câbles spécifiés par DENTIS. Sinon, une dégradation des performances de cet équipement pourrait en résulter.

**WARNING(AVERTISSEMENT)**

The instructions given in this document must be followed when handling the product. Failure to do so may endanger the safety of the installers or users.

As well as specific information on operating the entire product and conducting preventive maintenance, are provided in the USER'S MANUAL. For further information, please contact our sales network or our local network.

- Les instructions données dans ce document doivent être suivies lors de la manipulation du produit. Ne pas le faire peut mettre en danger la sécurité des installateurs ou des utilisateurs. Des informations spécifiques sur le fonctionnement du produit dans son ensemble et sur l'exécution de la maintenance préventive sont fournies dans le MANUEL DE L'UTILISATEUR. Pour plus d'informations, veuillez contacter notre réseau de vente ou notre réseau local

**WARNING(AVERTISSEMENT)**

The electrical connections must be performed by a qualified technician only.

The Lithium Battery replacement must be performed by a qualified technician only.

The electrical installation must be planned, performed and inspected by electrical engineers.

- Les connexions électriques doivent être effectuées uniquement par un technicien qualifié. L'installation électrique doit être planifiée, réalisée et inspectée par des ingénieurs électriciens.

**WARNING(AVERTISSEMENT)**

The LIGHTHEAD is designed to operate using a AC 100–240V 50/60Hz. Higher or lower voltages may affect the light intensity and operating life of the LEDs.

- La TÊTE D'ÉCLAIRAGE est conçue pour fonctionner sur AC 100-240V 50/60Hz. Des tensions plus élevées ou plus basses peuvent affecter l'intensité lumineuse et la durée de vie des LED.

**WARNING(AVERTISSEMENT)**

Damaged wire insulation may result in the risk of electric shock.

To protect against the risk of electrocution, connect the power cables carefully.

- L'isolation des fils endommagés peut entraîner un risque de choc électrique.

Pour vous protéger contre le risque d'électrocution, branchez soigneusement les câbles d'alimentation.

**WARNING(AVERTISSEMENT)**

Form of protection against electric shock of Major Surgical Luminaire(LUVIS L200) is Class I equipment. In order to avoid the risk of an electric shock, the equipment must be connected to a mains supply with PE(protective earth).

- La forme de protection contre le choc électrique du luminaire chirurgical majeur (LUVIS L200) est l'équipement de classe I. Afin d'éviter le risque de choc électrique, l'équipement doit être raccordé à une alimentation principale avec PE (terre protectrice).

**WARNING(AVERTISSEMENT)**

A main control switch must be installed for turning the system power-off.  
- Les alimentations électriques ne peuvent être installées et connectées que par un électricien ou un agent de service autorisé par DENTIS

**WARNING(AVERTISSEMENT)**

The power supplies may be installed and connected only by an electrician or a DENTIS authorized service agent.  
- Les alimentations électriques ne peuvent être installées et connectées que par un électricien ou un agent de service autorisé par DENTIS

**WARNING(AVERTISSEMENT)**

This product may only be repaired and special assembly work may only be carried out by DENTIS or a company that has been authorized by DENTIS.  
- Ce produit ne peut être réparé et des travaux d'assemblage spéciaux ne peuvent être effectués que par DENTIS ou une entreprise autorisée par DENTIS.

**WARNING(AVERTISSEMENT)**

Check the polarity of all electrical connections before turning on the power.  
- Vérifiez la polarité de toutes les connexions électriques avant d'allumer l'alimentation.

**WARNING(AVERTISSEMENT)**

The LIGHTHEAD must be connected to a backup power supply(BATTERY PACK or UPS). Always should be checked Battery capacity level before use by pressing the BATTERY CHECK BUTTON. A backup lifetime of a BATTERY PACK or UPS should be greater than 3 hours on power cut condition  
- La tête lumineuse doit être connectée à une alimentation de secours (BATTERY PACK ou UPS). Toujours vérifier le niveau de capacité de la batterie avant utilisation en appuyant sur le bouton de vérification de la batterie.  
L'autonomie de la batterie de secours ou de l'UPS doit être d'au moins 3 heures en cas de coupure de courant.

**WARNING(AVERTISSEMENT)**

DENTIS is not responsible for the customer's backup power supply.(BATTERY PACK or UPS)  
- DENTIS n'est pas responsable de l'alimentation de secours du client (BATTERIE ou UPS).

**WARNING(AVERTISSEMENT)**

Take care when handling the circuit boards: these boards are supplied in an electrostatic envelope and must be handled with great care.

- Manipulez les cartes de circuit imprimé avec précaution : ces cartes sont fournies dans une enveloppe électrostatique et doivent être manipulées avec grand soin

**WARNING(AVERTISSEMENT)**

Do not look directly into light source(LED).

- Ne regardez pas directement la source lumineuse (LED)

**WARNING(AVERTISSEMENT)**

The LIGHTHEAD brakes are adjusted during installation. Like all mechanical parts, the brakes are subject to wear.

Read just the brakes if the LIGHTHEAD no longer remains steady in any position.

Check the condition of the mounting surface.

- Les freins de la TÊTE D'ÉCLAIRAGE sont ajustés lors de l'installation. Comme toutes les pièces mécaniques, les freins sont sujets à l'usure. Réajustez les freins si la TÊTE D'ÉCLAIRAGE ne reste plus stable dans toutes les positions. Vérifiez l'état de la surface de montage.

**WARNING(AVERTISSEMENT)**

The operation and safety of the device may be affected by the removal of certain components during servicing operations.

- Le fonctionnement et la sécurité de l'appareil peuvent être affectés par le retrait de certains composants lors des opérations d'entretien.

**WARNING(AVERTISSEMENT)**

All the information in this manual has been checked out carefully and discerned as accurate one at the time of publication.

However, DENTIS takes no responsibilities of the results caused by default, omission, or misuse of it.

- Toutes les informations contenues dans ce manuel ont été soigneusement vérifiées et jugées exactes au moment de la publication. Cependant, DENTIS décline toute responsabilité pour les résultats causés par des défauts, des omissions ou une mauvaise utilisation de celles-ci.

**WARNING(AVERTISSEMENT)**

DENTIS has rights to modify the product itself or specifications of the product without any prior notice, as well as rights not to renew that modification on this manual.

- DENTIS se réserve le droit de modifier le produit lui-même ou les spécifications du produit sans préavis, ainsi que le droit de ne pas renouveler cette modification dans ce manuel.

**WARNING(AVERTISSEMENT)**

Do not press more than two buttons simultaneously.  
In case of abnormal operation (overpower) of this product, stop the medical treatment and contact the place of purchase.

- Ne pas appuyer sur plus de deux boutons simultanément. En cas de fonctionnement anormal (surcharge) de ce produit, arrêtez le traitement médical et contactez le lieu d'achat.

**WARNING(AVERTISSEMENT)**

The circuit of medical device must be installed in the state with the means to electrically separate with in all poles from the POWER SUPPLY.

- Le circuit du dispositif médical doit être installé dans un état permettant une séparation électrique de tous les pôles de l'ALIMENTATION.

**WARNING(AVERTISSEMENT)**

- Do not place the Mobile Type ME equipment where it is difficult to disconnect the Power Cord.

- Ne placez pas l'équipement ME de type mobile à un endroit où il est difficile de débrancher le cordon d'alimentation.

**WARNING(AVERTISSEMENT)**

- Use a power supply with at least 20A circuit breakers

- Utilisez une alimentation électrique avec des disjoncteurs d'au moins 20A.













**WARNING(AVERTISSEMENT)**

When operating the surgical luminaire, do not use the battery pack alone. Use it strictly for emergency purpose only.

- Lors de l'utilisation de la lampe chirurgicale sans ombre, ne utilisez pas uniquement la batterie. Utilisez-la strictement à des fins d'urgence uniquement.

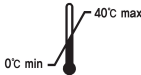
### 3. Symbol(Symbole)

Symbol (Symbole)	Meaning (Signification)	Remark (Remarque)
	<p><b>CE Mark</b> The device bears the CE mark and complies with the requirements of Regulation (EU) MDR 2017/745 for medical device. - L'appareil porte le marquage CE et est conforme aux exigences du Règlement (UE) MDR 2017/745 relatif aux dispositifs médicaux.</p>	④, ⑤, ⑥
	<p>MEDICAL – GENERAL MEDICAL EQUIPMENT AS TO ELECTRICAL SHOCK, FIRE AND MECHANICAL HAZARDS ONLY IN ACCORDANCE WITH [ANSI/AAMI ES60601-1:2005/(R)2012 and A1:2012, C1:2009/(R)2012 and A2:2010/(R)2012, CAN/CSA C22.2 No. 60601-1:14] - MATÉRIEL MÉDICAL – GÉNÉRALITÉS CONCERNANT LES CHOCS ÉLECTRIQUES, LES INCENDIES ET LES DANGERS MÉCANIQUES SEULEMENT CONFORMÉMENT AUX [ANSI/AAMIES 60601-1:2005/(R)2012 et A1:2009/(R)2012/(R)2012, CAN/CSA C222 No. 60-114]</p>	⑥
	<p>Recommendation - Recommandation</p>	⑤
	<p>Protective earth (ground) - Terre de protection</p>	②
	<p>Alternating current - Courant alternative</p>	②
	<p>Stand-by - Mode veille</p>	③
	<p>Do not throw away with general household waste - Ne pas jeter avec les déchets ménagers ordinaires</p>	⑤
	<p>Caution - ATTENTION</p>	⑤
	<p>Warning - AVERTISSEMENT</p>	⑤
	<p>Follow instructions for use - Suivre les instructions d'utilisation</p>	⑥
	<p>General mandatory action - Action obligatoire générale</p>	①
	<p>Pushing prohibited - Pousser interdit</p>	①

	KEEP AWAY FROM RAIN - GARDER À L'ÉCART DE LA PLUIE	④
	USE NO HAND HOOKS - NE PAS UTILISER DE CROCHETS À MAIN	④
	FRAGILE, HANDLE WITH CARE - FRAGILE, MANIPULER AVEC PRÉCAUTION	④
	THIS WAY UP - TOUJOURS GARDER DANS CE SENS	④
	Do not build up more than 5 boxes - Ne pas empiler plus de 5 boîtes	④
	Manufacturer - Fabricant	④, ⑤, ⑥
	Europe Representative - Représentant en Europe	⑤, ⑥
	Date of manufacture - Date de fabrication	⑤, ⑥
	Temperature between 0 - 40°C - Température entre 0 - 40°C	④
	- Humidity between 0 - 80%RH - Humidité entre 0 - 80 %HR	④
	- Atmospheric pressure between 80Kpa – 106Kpa - Pression atmosphérique entre 80 kPa – 106 kPa	④
	Recycling - Recyclage	④, ⑤

No.	Location(Emplacement)
①	Marking on the outside of ME EQUIPMENT - Marquage à l'extérieur de l'ÉQUIPEMENT ME
②	Marking on the inside of ME EQUIPMENT - Marquage à l'intérieur de l'ÉQUIPEMENT ME
③	Marking on the controls of ME EQUIPMENT - Marquage sur les commandes de l'ÉQUIPEMENT ME
④	Marking on the packing label of ME EQUIPMENT - Marquage sur l'étiquette d'emballage de l'ÉQUIPEMENT ME
⑤	Marking on the manual of ME EQUIPMENT - Marquage sur le manuel de l'ÉQUIPEMENT ME
⑥	Marking on the label of ME EQUIPMENT - Marquage sur l'étiquette de l'ÉQUIPEMENT ME

## 4. Introduction

### 4.1 Intended use

- Major Surgical Luminaire(L200) is intended to be used to provide visible illumination of the surgical area or the patient during surgical operations, diagnosis and treatment.
- Classification under the provision of 93/42/EEC(MDR) : Class I
  - Major Surgical Luminaire(L200) is classified as a Class I device.
- Classification under the provision of FDA (U.S. Food and Drug Administration) : Class II
  - Major Surgical Luminaire(L200) is classified as a Class II(exempt) device.
- Form of protection against electric shock : Class I
  - Major Surgical Luminaire(L200) is classified as Class I
- Degree of protection against flammability
  - Major Surgical Luminaire(L200) is classified as a device not suitable to be used in a potentially flammable environment.
  - Do not use near flammable materials.
- Method(s) of sterilization or disinfection recommended by the manufacturer
  - The SIDE HANDLE should be cleaned with cloths, and the MAIN HANDLE should be sterilized with sterilizer regularly to prevent disinfection.
- Mode of operation
  - Classification of Major Surgical Luminaire(L200): continuous operation.

## 4.2 General description

- The user must ensure that the device works properly and is in a satisfactory condition before each use.
- This DENTIS device is intended only for use in the field of medical. It is impermissible to use the device for a purpose for which it was not intended.
- “Proper Use” includes following all the instructions for use and ensuring that all inspections and service tasks are performed.
- Apply and meet the overarching guidelines and/or national laws, national regulations and the rules of technology for medical devices applicable for startup and use of the device for the intended purpose.
- The user must observe the following:
  - Only use properly operating equipment.
  - Protect himself or herself and third parties from danger.
  - Avoid contamination from the device.
- During use, the following national regulations must be observed:
  - The applicable health and safety regulations.
  - The applicable accident prevention regulations.
- To ensure that device maintains their value and are always ready for use, they must be serviced once a year as recommended.
- Before using the products, You must receive training by authorized person of the DENTIS.
- The safety checks must be performed every year.
- Repair and service of the device is authorized only to those who meet the requirements below:
  - Technicians of authorized dealers specially trained by DENTIS.
  - The trained technicians of DENTIS branches.

### 4.3 Environmental requirement

- Conditions of the usage environment
- Temperature : 0 - 40 °C
- Relative Humidity : 30 - 90 %RH
- Atmospheric pressure: 0 - 2,000 m (106 - 80 Kpa)
- Conditions of storage transportation environment
- Temperature : 0 - 40 °C
- Relative Humidity : 0 - 80 %RH
- Atmospheric pressure: 0 - 2,000 m (106 - 80 Kpa)

### 4.4 Safety information

- Major Surgical Luminaire(L200) as a medical device complies with the safety regulation EN/IEC 60601-1.
- Accessory equipment connected to the analog and digital interfaces must be certified according to the respective EN/IEC standards (e.g. EN/IEC 60601-2-41 for Particular requirements, EN/IEC 60601-1 for General requirements).
- Furthermore all configurations shall comply with the ME Equipment of Collateral Standard EN/IEC 60601-1-2. Everybody who connects additional equipment to the signal input part or signal output part configures a ME Equipment, and is therefore responsible that the ME Equipment complies with the requirements of standard EN/IEC 60601-1.
- If in doubt, consult the technical service department or your local representative.
- For EU Countries
  - Europe Representative  
KTR Europe GmbH  
Mergenthalerallee 77, 65760  
Eschborn, Germany
- Safety is everyone's obligation and responsibility.
- The safe use of this product is related to everyone such as installer, user, operator and equipment's manager.



- It must read and learn this user's manual is compulsory before installation, using, cleaning, fixing or operation of this product or its accessories. Pay particular attention and be familiar with warning symbols about safety.
- If do not follow safety direction of this manual, you can get injured or accident when you operate this product. After read carefully and understand this manual, use this product.
- This manual is in keep a place where you can find easily.

#### 4.5 Warranty regulation

- DENTIS warrants all products against defects in materials or workmanship for two year from time of delivery.
- DENTIS's sole obligation under the warranty is to provide parts for the repair, or at its option, to provide the replacement product (excluding labor).
- The buyer shall have no other remedy. All special, incidental, and coincidental damages are excluded.
- Written notice of breach must be given to DENTIS within the warranty period.
- The warranty does not cover damage resulting from improper installation or maintenance, accident or misuse.
- The warranty does not cover damage resulting from the use of cleaning, disinfecting or sterilization chemicals and processes.
- The Failure to follow instructions provided in the DENTIS Instructions for Use (operation and maintenance instructions) may void the warranty.
- LED PCB ASS'Y is covered under 60,000 hrs warranty.

## 4.6 Electromagnetic Compatibility

### 4.6.1 Emission

This ME equipment is intended for use in Professional healthcare facility environment.		
Emission test	Compliance	Guidance
Conducted Disturbance CISPR 11(EN 55011)	Complies (Group 1, Class A)	This ME equipment uses RF energy only for its internal function. Therefore, its RF emissions are very low and are not likely to cause any interference in nearby electronic equipment.
Radiated Disturbance CISPR 11(EN 55011)		
Harmonic current IEC 61000-3-2	Complies	This ME equipment is suitable for use in all establishments other than domestic premises and those directly connected to the public low-voltage power supply network that supplies buildings used for domestic purposes.
Voltage fluctuations and flicker IEC 61000-3-3	Complies	

### 4.6.2 Immunity

This ME equipment is intended for use in Professional healthcare facility environment.																	
Immunity test	EN 60601-1-2:2015	Compliance															
Electrostatic Discharge( ESD) IEC 61000-4-2	Direct: $\pm 8$ kV Contact $\pm 2$ kV, $\pm 4$ kV, $\pm 8$ kV, $\pm 15$ kV Air Indirect: $\pm 8$ kV HCP/VCP	Complies															
Radio Frequency Electromagnetic Fields IEC 61000-4-3	3 V/m @ 80 MHz ~ 2.7 GHz 80 % AM at 1 kHz	Complies															
Proximity fields from RF wireless communications equipment IEC 61000-4-3	<table border="1"> <thead> <tr> <th>Frequency (MHz)</th> <th>Modulation</th> <th>Immunity Level (V/m)</th> </tr> </thead> <tbody> <tr> <td>385</td> <td>**Pulse Modulation: 18 Hz</td> <td>27</td> </tr> <tr> <td>450</td> <td>*FM + 5Hz deviation: 1 kHz sine</td> <td>28</td> </tr> <tr> <td>710 745 780</td> <td>**Pulse Modulation: 217 Hz</td> <td>9</td> </tr> <tr> <td>810 870 930</td> <td>**Pulse Modulation: 18 Hz</td> <td>28</td> </tr> </tbody> </table>	Frequency (MHz)	Modulation	Immunity Level (V/m)	385	**Pulse Modulation: 18 Hz	27	450	*FM + 5Hz deviation: 1 kHz sine	28	710 745 780	**Pulse Modulation: 217 Hz	9	810 870 930	**Pulse Modulation: 18 Hz	28	Complies
	Frequency (MHz)	Modulation	Immunity Level (V/m)														
	385	**Pulse Modulation: 18 Hz	27														
	450	*FM + 5Hz deviation: 1 kHz sine	28														
	710 745 780	**Pulse Modulation: 217 Hz	9														
	810 870 930	**Pulse Modulation: 18 Hz	28														

	<table border="1"> <tr> <td>1 720</td> <td rowspan="3">**Pulse Modulation: 217 Hz</td> <td rowspan="3">28</td> </tr> <tr> <td>1 845</td> </tr> <tr> <td>1 970</td> </tr> <tr> <td>2 450</td> <td>**Pulse Modulation: 217 Hz</td> <td>28</td> </tr> <tr> <td>5 240</td> <td rowspan="3">**Pulse Modulation: 217 Hz</td> <td rowspan="3">9</td> </tr> <tr> <td>5 500</td> </tr> <tr> <td>5 785</td> </tr> </table> <p>** The carrier shall be modulated using a 50 % duty cycle square wave signal. * As an alternative to FM modulation, 50 % pulse modulation at 18 Hz may be used because while it does not represent actual modulation, it would be worst case.</p>	1 720	**Pulse Modulation: 217 Hz	28	1 845	1 970	2 450	**Pulse Modulation: 217 Hz	28	5 240	**Pulse Modulation: 217 Hz	9	5 500	5 785	
1 720	**Pulse Modulation: 217 Hz	28													
1 845															
1 970															
2 450	**Pulse Modulation: 217 Hz	28													
5 240	**Pulse Modulation: 217 Hz	9													
5 500															
5 785															
Fast Transients IEC 61000-4-4	<table border="1"> <tr> <td>Voltage</td> <td>AC/DC power ports</td> <td>Signal ports</td> </tr> <tr> <td>Test voltage</td> <td>± 2 kV</td> <td>± 1 kV</td> </tr> </table> <p>- 100 kHz repetition frequency</p>	Voltage	AC/DC power ports	Signal ports	Test voltage	± 2 kV	± 1 kV	Complies							
Voltage	AC/DC power ports	Signal ports													
Test voltage	± 2 kV	± 1 kV													
Surges IEC 61000-4-5	<table border="1"> <tr> <td>Voltage</td> <td>Power lines</td> </tr> <tr> <td>Test voltage</td> <td>Line to Line : ± 0.5 kV, ± 1 kV Line to ground: ± 0.5 kV, ± 1 kV, ± 2 kV</td> </tr> </table>	Voltage	Power lines	Test voltage	Line to Line : ± 0.5 kV, ± 1 kV Line to ground: ± 0.5 kV, ± 1 kV, ± 2 kV	Complies									
Voltage	Power lines														
Test voltage	Line to Line : ± 0.5 kV, ± 1 kV Line to ground: ± 0.5 kV, ± 1 kV, ± 2 kV														
RF Continuous Conducted IEC 61000-4-6	<p>3 V @ 0.15 MHz ~ 80 MHz 6 V @ in ISM bands between 0.15 MHz and 80 MHz 80 % AM at 1 kHz</p>	Complies													
Power Frequency Magnetic Fields IEC 61000-4-8	<p>30 A/m @ 50 Hz or 60 Hz</p>	Complies													
Voltage Dips, Interruptions, and Variations IEC 61000-4-11	<ul style="list-style-type: none"> <li>• Voltage Dips 0 % UT; 0,5 cycle At 0°, 45°, 90°, 135°, 180°, 225°, 270° and 315° 0 % UT; 1 cycle and 70 % UT; 25/30 cycles Single phase: at 0°</li> <li>• Voltage Interruptions 0 % UT; 250/300 cycle</li> <li>• Voltage Variations</li> </ul> <table border="1"> <tr> <td>Frequency (Hz)</td> <td>Ranges</td> </tr> <tr> <td>50</td> <td>49, 50, 51</td> </tr> <tr> <td>60</td> <td>59, 60, 61</td> </tr> </table>	Frequency (Hz)	Ranges	50	49, 50, 51	60	59, 60, 61	Complies							
Frequency (Hz)	Ranges														
50	49, 50, 51														
60	59, 60, 61														

## 5. LIGHTHEAD specification

### 5.1 Technical specification (In accordance with EN/IEC 60601-2-41)

- STANDARD SPECIFICATION

Specifications		Unit	LUVIS L200	Remark
<b>Normal Mode</b>				
Central illuminance $E_c$ (@1m)		lx	160,000	
Electronic adjustment range		%	25 ~ 100	
Light field diameter d10		cm	20 ~ 30	
Light field diameter d50		cm	12 ~ 18	
Diameter d50/d10		N/A	> 0.55	
Depth of illumination at 20%		cm	150	
Depth of illumination at 60%		cm	85	
Color temperature (3 levels)		K	3,800/4,300/4,800	$\pm 300K$
Color rendering index Ra		N/A	95	$\pm 3$
Special color rendering index R9		N/A	90	$\pm 3$
Shadow dilution	With tube	%	98	
	With one mask	%	80	
	With two mask	%	70	
	With one mask, at base of tube	%	70	
	With two mask, at base of tube	%	65	
Radiation energy		$mW/m^2 \cdot lx$	3.49	
Illumination energy( $E_e$ )		$W/m^2$	546.7	
<b>Endo Mode</b>				
Illumination		lx	8,000	$E_c * 5\%$

\* Optical values are measured with a tolerance of  $\pm 10\%$

## 5.2 Electrical specification (In accordance with EN/IEC 60601-1)

- **SMPS TECHNICAL DATA**

Content	Single LIGHTHEAD	Dual LIGHTHEAD
Input	AC 100-240 V, 50/60 Hz (1.8/0.8 A typical at AC 115/230 V full load)	AC 100-240 V, 50/60 Hz (1.8/0.8 A typical at AC 115/230 V full load) x 2
Output	DC 28 V, 6.4 A	(DC 28 V, 6.4 A) x 2

- **RATING**









Content	Rating	Remark
L200 LIGHTHEAD	AC 100–240 V, 67 VA, 50/60 Hz	Single LIGHTHEAD
	AC 100-240 V, 163 VA, 50/60 Hz	Single LIGHTHEAD with CAMERA and BATTERYPACK
BATTERY PACK	DC 14.52 V, 39.2 Ah, 569.18 Wh	Lithium-ion Battery

### 5.3 Mechanical specification

Type	Item	Length(mm)	Weight(kg)	Remark
SA300	CEILING COVER	Φ604	2.0	
	CENTRAL AXIS MIDDLE COVER	Φ170 x 215	0.5	Purpose : 2WS
	CEILING TUBE	Φ109 x 316	14.0	
		Φ109 x 416	17.0	Purpose : 2WS
	CENTRAL AXIS	3Fold (1000/850/700)	31.0	
		2Fold (850/700)	19.0	
		1Fold (850)	12.0	
	SPRING ARM	937	8.0	SA300 LCH1
				SA300 LCH2
		900		SA300 STD1
				SA300 STD2
	MOBILE STAND	-	62.0	
	LIGHTHEAD L200	670 x 670	17.5 (18.5)	3Axis ( CAMERA : 1kg)
670 x 670		14.8	2Axis	
BATTERY PACK	L x W x H : 244 x 164 x 120	3.8		



\* PLUG TYPE : 3P Plug(3P), None Plus(W/S)

### 5.4 Configuration of SPRING ARM & LIGHTHEAD

Model	SA300(3P, WS) 3 Axis		SA300(3P, WS) 2 Axis	
	STD1	STD2	LCH1	LCH2
L200	 14–21kg		 125–204Nm	
M200, M210		 9–15kg		 91–136Nm
M300, M310		 9–15kg	 125–204Nm	
L400, M400	 14–21kg		 125–204Nm	

\* Check and install the Payload of the Spring Arm, considering the LIGHTHEAD weight

### 5.5 Configuration of SPRING ARM & Specific options

AC2000(W/S) 3 Axis-Monitor	2 Axis-Mobile(W/S)	
	LCH1	LCH2
<b>REF 1938769</b> : AA910,N,nEwS, 9-15kg,R9010	 125–204Nm	 91–136Nm
		

\* Check and install the Payload of the Specific options

### 5.6 Internal Camera(optional) specification

Seperation	Specifications	Remark
Image Sensor	1/2.8" SONY STARVIS CMOS	
Zoom Ratio	30X Optical Zoom	
Image Point	Approx. 2.13 Megapixels	
Min. Object Distance	800mm to 1100mm	
Video System	Full HD 1080p, 1080i, 720p, 720i	
Video Output Signal	HD-SDI	75Ω BNC

### 5.7 Other characteristic

Specifications	LUVIS L200	Remark
Protection against electric shock	Class I Protection	
Protection against harmful ingress of water or particulate matter	Ordinary	Head part: IP42
Method of sterilization	See the USER'S MANUAL	



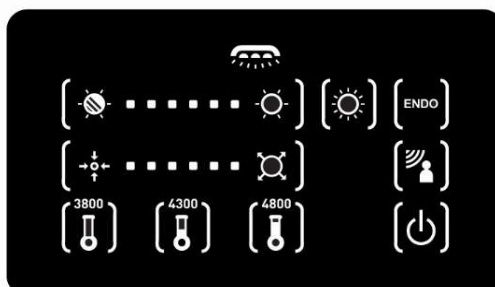

## 6. USE

### 6.1 ARM CONTROLLER

- The LIGHTHEAD can be controlled using the ARM CONTROLLER

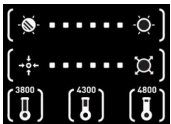

#### FUNCTION

LUVIS L200		
	On/Off button (Standby)	<ul style="list-style-type: none"> <li>Press to turn on, press and hold (2 Second) to turn off.</li> <li>The light turns on, at the last illumination level stored in its memory.</li> </ul>
	Level adjustment for the selected function	<ul style="list-style-type: none"> <li>Press repeatedly to change levels</li> <li>Touch panel &amp; LED indicator</li> <li>Six illumination levels</li> <li>Six light field diameter levels</li> <li>Three color temperature levels 3,800K / 4,300K / 4,800K</li> </ul>
	Maximum mode	<ul style="list-style-type: none"> <li>Illumination : Level 6</li> <li>Light field diameter : Level 6</li> </ul>
	ENDO mode	<ul style="list-style-type: none"> <li>Toggles from NORMAL mode to ENDO mode or vice versa.</li> </ul>
	Sensor On/Off button	<ul style="list-style-type: none"> <li>4-sensor operating mode</li> <li>Dilution effect up-grade</li> </ul>

**6.2 HANDLE TOUCH CONTROLLER**

- The **LIGHTHEAD** can be controlled using the **HANDLE TOUCH CONTROLLER**

**The control panel of the HANDLE TOUCH CONTROLLER**

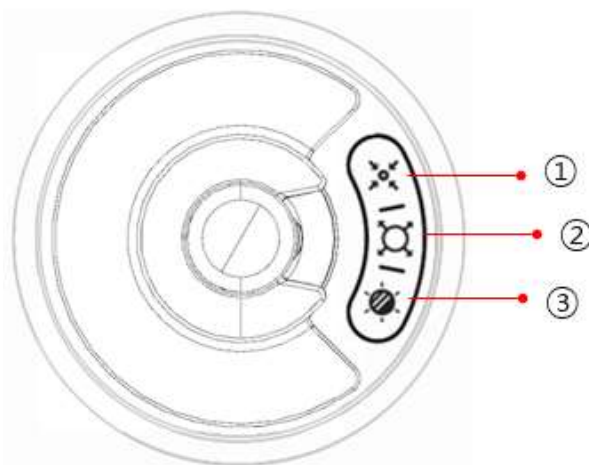

<b>LUVIS L200</b>		
①	Light field diameter level down button	<ul style="list-style-type: none"> <li>• The light field diameter decreases.</li> </ul>
②	Light field diameter level up button	<ul style="list-style-type: none"> <li>• The light field diameter increases.</li> </ul>
③	Illumination level button	<ul style="list-style-type: none"> <li>• The illumination level can be changed (Rotation) 1 → 2 → 3 → 4 → 5 → 6 → 1 → 2...</li> </ul>

### 6.3 CAMERA TOUCH CONTROLLER(optional)

- The LIGHTHEAD can be controlled using the CAMERA TOUCH CONTROLLER

The control panel of the CAMERA TOUCH CONTROLLER

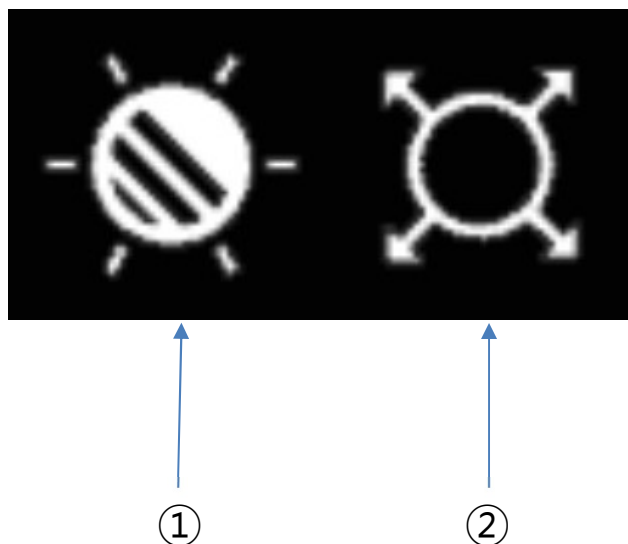

LUVIS L200		
①	Light field diameter level button	<ul style="list-style-type: none"> <li>The light field diameter can be changed. (Rotation) 1 → 2 → 3 → 4 → 5 → 6 → 1 → 2...</li> </ul>
②	Illumination level button	<ul style="list-style-type: none"> <li>The illumination level can be changed (Rotation) 1 → 2 → 3 → 4 → 5 → 6 → 1 → 2...</li> </ul>

### 6.4 WALL CONTROL BOX(optional)

**Note:** The control panel depends on the configuration installed.

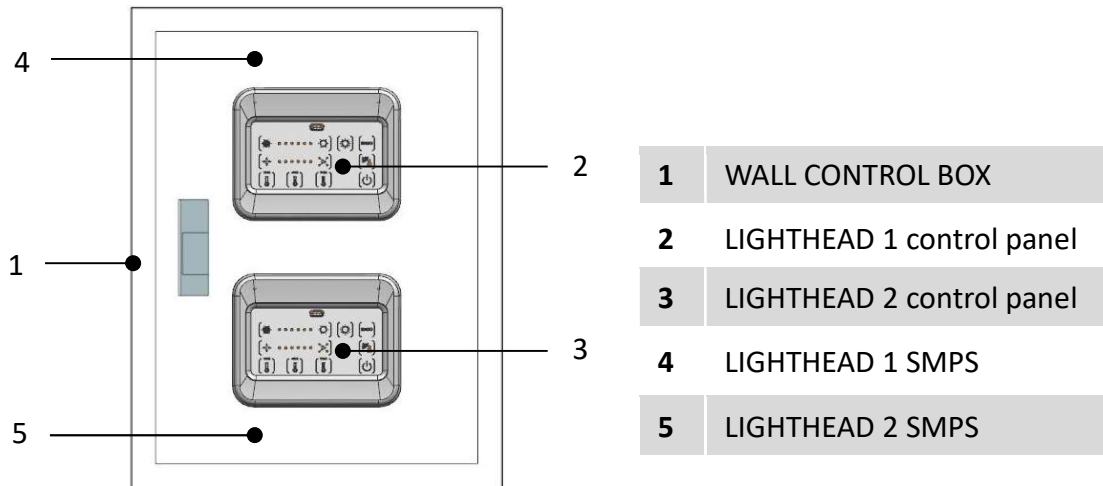

### The control panel of the WALL CONTROL BOX

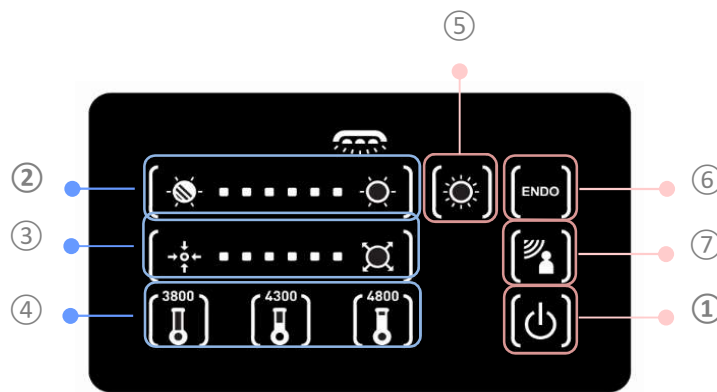

1	On/Off button(Standby)
2	Illuminations variation button
3	Light field diameter variation button
4	Variable color temperature button
5	Maximum mode button
6	ENDO mode button
7	Sensor On/Off button

### 6.5 Controlling the INTERNAL CAMERA(optional)

- The INTERNAL CAMERA can be controlled using the ARM CONTROLLER or WALL CONTROL BOX.

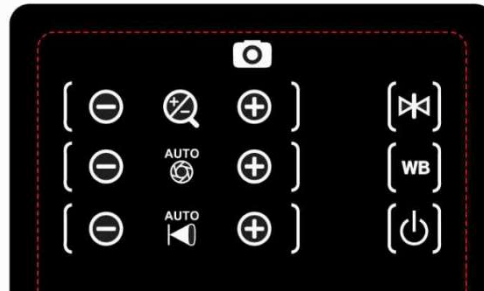

#### FUNCTION

LUVIS L200 INTERNAL CAMERA		
	On/Off button (Standby)	<ul style="list-style-type: none"> <li>• Press to turn on the camera.</li> <li>• Press and hold (2 Second) to turn off the camera.</li> </ul>
	White Balance	<ul style="list-style-type: none"> <li>• White Balance Control button</li> </ul>
	Freeze	<ul style="list-style-type: none"> <li>• Video STOP button</li> </ul>
	Zoom In/Out	<ul style="list-style-type: none"> <li>• ZOOM Lens Control button</li> </ul>
	Aperture In/Out, Auto	<ul style="list-style-type: none"> <li>• Aperture Control button</li> </ul>
	Focus In/Out, Auto	<ul style="list-style-type: none"> <li>• Focus Control button</li> </ul>

6.6 Positioning

Positioning the L200 LIGHTHEAD

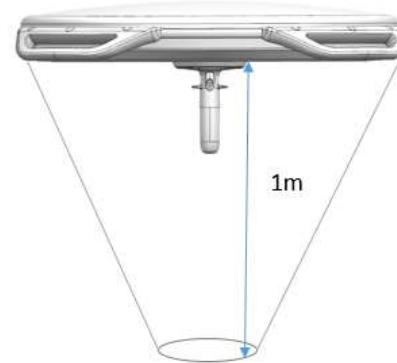
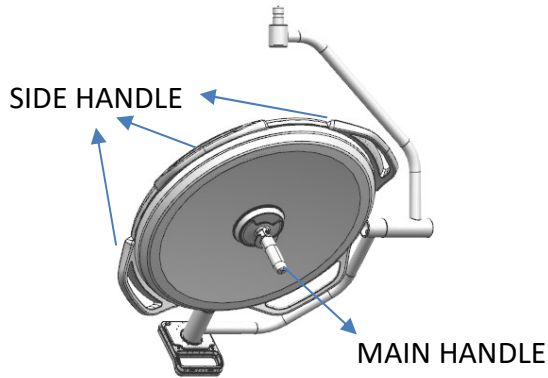

- Use the MAIN HANDLE or SIDE HANDLE to position the L200 LIGHTHEAD before the operation.
- This MAIN HANDLE can be removed for sterilization.

- Recommended distance : 1m

(Unit: mm)

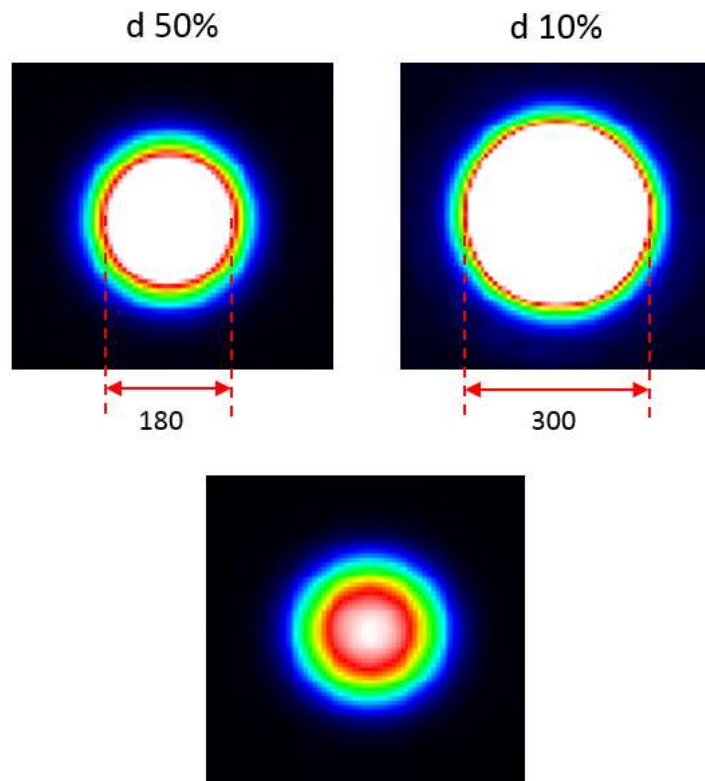

Pattern size

6.7 MAIN HANDLE



**WARNING**

After each sterilization and before using the MAIN HANDLE again :

- Check MAIN HANDLE for cracks.
- Check that the MAIN HANDLE click into place correctly on the LIGHTHEAD.

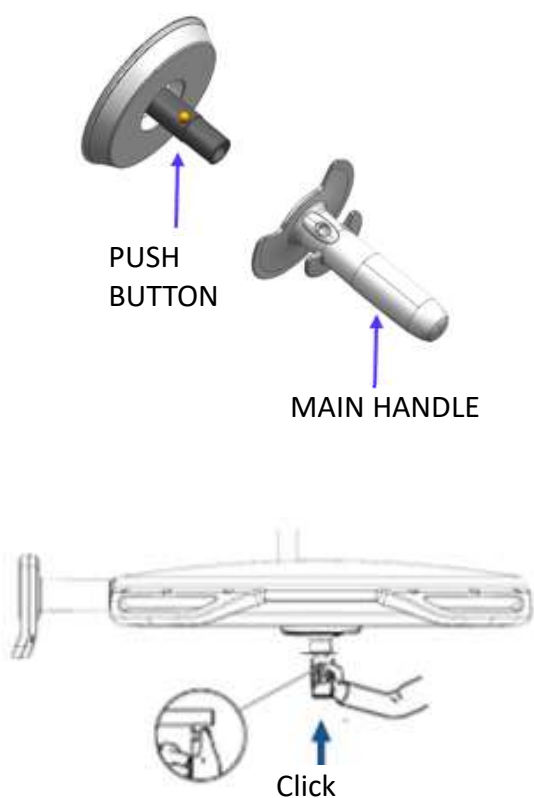

**Attaching the MAIN HANDLE**

- Insert the MAIN HANDLE into the mount until it clicks into place

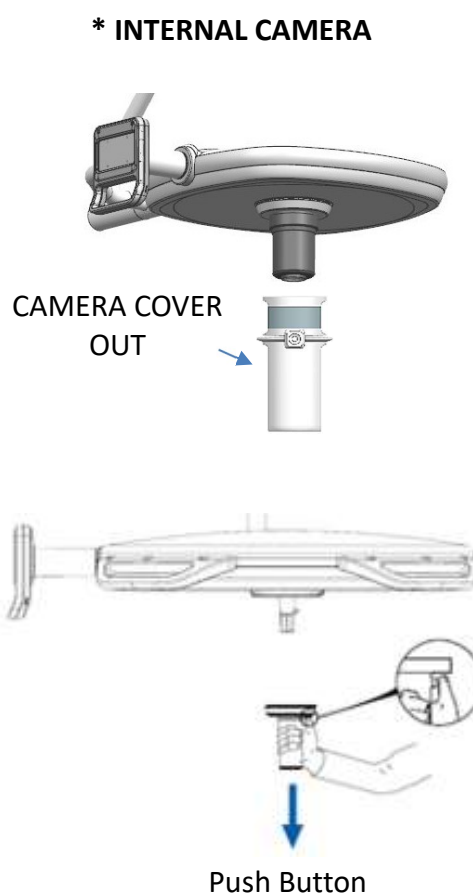

**Detaching the MAIN HANDLE**

- Press down on the PUSH BUTTON while removing the MAIN HANDLE.

## 6.8 Mobile Type

### SMPS



#### WARNING

The mains plug should not be difficult to remove, place it in position  
(Means for isolation is disconnect mains plug)

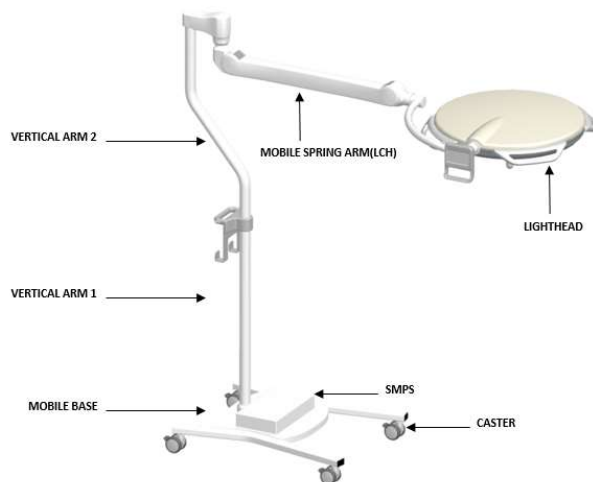

- While moving the mobile type for use, please fold the spring arm as much as possible and hold the MOBILE SPRING ARM by hands.
- And please make sure, that all CASTERS are moveable. (Brakes are loosened, no cables in the movement range of the stand)
- Storage method of device:  
The mobile type must be positioned so that the user and patient can avoid any collisions with the devices.

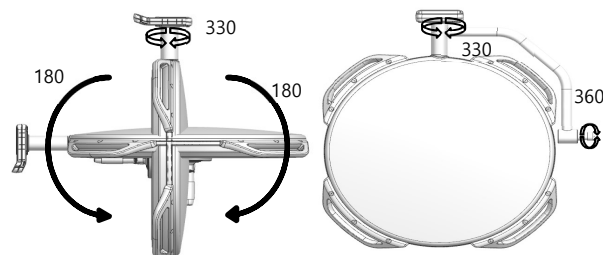

### 6.9 BATTERY PACK



**WARNING**

The lithium-ion BATTERY PACK is a consumable item and should be replaced every 12 months by service personnel.(It can vary depending on the number of use.)  
Check the BATTERY PACK capacity level by pushing the BATTERY CHECK BUTTON.



**WARNING**

The mains plug should not be difficult to remove, place it in position  
(Means for isolation is disconnect mains plug)



**WARNING**

After the first installation, you must fully charge the BATTERY PACK.

The control panel of the BATTERY PACK CONTROLLER



No.	Function	Description
①	Battery charging level indicator	<ul style="list-style-type: none"> <li>The charging level can be indicated 25%, 50%, 75%, 100%</li> </ul>
②	BATTERY CHECK BUTTON	<ul style="list-style-type: none"> <li>Press to check the charging level of the BATTERY PACK</li> </ul>

- The BATTERY PACK can be used for a minimum period of 3hrs with fully charged.(100%)

## 7. Performance characteristic

### 7.1 LIGHTHEAD on the SPRING ARM

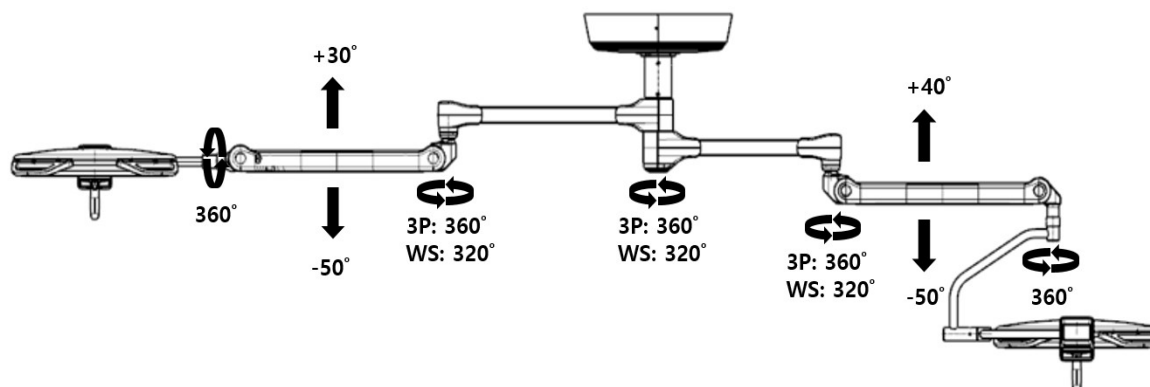

#### WARNING

If this device is operated beyond the indicated angles, it can be damaged. During positioning, eventual collisions between the LIGHTHEAD, SPRING ARMS and other devices must be avoided.



#### WARNING

This image was constructed to demonstrate the product's operating range. The image may differ from the actual product.

## 8. Cleaning and Sterilization



### Warning

Cleaning and sterilization procedures vary from facility to facility and therefore it is not possible to specify a single procedure. The user should contact a specialist in the hospital and apply the recommended procedures according to the product. If you have any questions about the compatibility of your medication, please contact the DENTIS Customer Center.

The treatment level required for cleaning and disinfection of the MAIN HANDLE is a low level of disinfection. It is classified as non-critical devices with a low risk of infection, except for the use of sterilizable handles.

Contact your place of purchase in case of failure or damage.



### Warning

The use of cleaning agents containing the following substances is not permitted.

- High concentrations of organic and inorganic acids and chlorinated hydrocarbons

### 8.1 Cleaning the equipment



### Warning

Before cleaning turn off the power and wait until LIGHTHEAD is sufficiently cooled.

Wear gloves when cleaning and disinfecting.

Do not spray cleaning and disinfectant directly into the LIGHTHEAD.

- Make sure that the system is powered off and the LIGHTHEAD is sufficiently cooled.
- Prepare cleaning agents and disinfectants. For cleaning agents, follow the manufacturer's instructions for use.
- Moisten a clean, lint-free, soft cloth with cleaning solution and remove excess moisture.
- Clean the area using a cloth soaked with cleaning agent.
- Clean the device using a cloth soaked with clean water.
- Wipe all surfaces with a clean, dry cloth to remove any residue.
- Make sure all cleaning and disinfectant residues have been removed before using the light.

## 8.2 MAIN HANDLE AUTOMATIC CLEANING

- After the operation, remove the MAIN HANDLE from the surgical lamp.
- Remove visible foreign substances using a soft brush and cloth in warm water flowing through the MAIN HANDLE for at least 1 minute.
- Place the MAIN HANDLE in the cleaning equipment and carry out the cleaning using an enzyme detergent according to the following cleaning conditions.

No.	Condition	Temperature(°C)	Minimum time(Min)
1	Pre-cleaning	20-40	1
2	Cleaning	20-40	5
3	Cleaning	20-40	2
4	Rinsing	20-40	10
5	Rinsing	20-40	10
6	Dry	50-70	90

- Remove the MAIN HANDLE from the cleaning equipment and ensure that the cleaning is complete.
- Check for foreign substances left inside and outside the MAIN HANDLE, if it is necessary, repeat the cleaning process
- Protect the cleaned and dried MAIN HANDLE from re-contamination.

## 8.3 MAIN HANDLE MANUAL CLEANING

- After the operation, remove the MAIN HANDLE from the surgical lamp.
- Immerse the MAIN HANDLE in the washing tank for at least 5 minutes in the diluted enzyme detergent. (Follow the manufacturer's instructions for use of the cleaner.)
- To prevent blood or foreign substances from drying out, soak the separated MAIN HANDLE in distilled water or tap water for 15 minutes to remove any foreign substances, then clean it with a soft brush and a lint-free cloth.
- Check inside and outside of the MAIN HANDLE for debris, and repeat cleaning if any debris remains.
- Rinse thoroughly with clean water and wipe clean with a lint-free cloth to dry.
- Protect the cleaned and dried main handle from re-contamination

### 8.4 Sterilization(MAIN HANDLE, CAMERA COVER & CAMERA SEALING)



**Warning**

Do not allow foreign substances to enter the MAIN HANDLE during sterilization. MAIN HANDLE is guaranteed for up to 100 sterilization cycles when the same sterilization conditions are applied.

In the case of MAIN HANDLE, sterilization may cause wear, cracks, and discoloration. If these signs are detected, stop using the handle and replace it.

The MAIN HANDLE being stored must be kept clean and sterile before use.

If you are not wearing a sterile suit, be careful and do not touch the sterilized MAIN HANDLE.

- Sterilize the cleaned MAIN HANDLE according to the process below.
- Make sure the MAIN HANDLE is clean, wrap the HANDLE in sterile packaging (double packaging or equivalent) and seal it.
- When putting the MAIN HANDLE into the sterilizer, make sure that the hole is facing down to allow water to flow down.
- Place the MAIN HANDLE in the Pressurized Steam Sterilizer (AUTO CLAVE) and proceed with the sterilization cycle according to the sterilization conditions. Using chemical sterilization is prohibited
- Follow the sterilizer manufacturer's instructions and sterilization conditions of your country.
- When storing after sterilization, store in a tray in a sterile packaging material (room temperature storage)

Sterilization Condition	
<ul style="list-style-type: none"> <li>• Operating Condition</li> <li>– Temperature : 132 °C</li> <li>– Pressure : 160 ± 50kPa (1.6 ±0.5 kgf/cm<sup>2</sup>)</li> <li>– Time : 10 min</li> <li>– Dry : 16 min</li> </ul>	 <p>Autoclave</p>
Sterile packaging	
<ul style="list-style-type: none"> <li>• Sterile Clothing</li> <li>– KIMGUARD sterile clothing</li> <li>– Model : KC500</li> </ul>	

## 9. Maintenance



### WARNING

A electrical and mechanical check-up should be done every year.  
Disconnect the pendant system from the mains before any maintenance work to prevent electric shock.



### WARNING

Check points on maintenance work

- Defects of paint
- Plastic fissures
- Loosened parts.
- Free rotation / limit stops and deformation of the suspension.
- The connection between LIGHTHEAD and pendant system.
- Defect of the SECURING SEGMENT.
- The faultless function of the LIGHTHEAD.



### WARNING

In case of failure or damage, please contact your supplier.

## 10. Troubleshooting

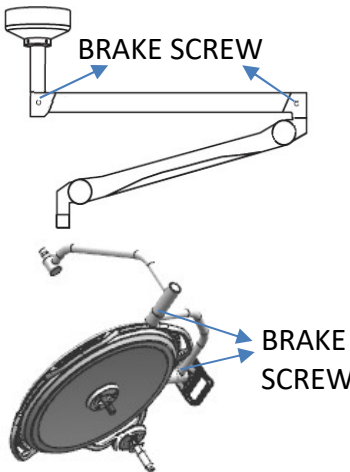
L200 Product			
No.	Problem	Cause	Corrective action
1	If the LED light on the LIGHTHEAD does not turn on.	Power cut	Check if supply mains are operating.
		Does not working of a backup power supply(UPS).	Please contact your supplier.
		Others	Press the stand-by button of the control panel and check that the LED turns on. (If green light does not light on, do not attempt to repair it yourself, please contact your supplier)
2	If LIGHTHEAD is not fixed after handling, moves left and right	BRAKE SCREW incorrectly adjusted	<p>Check that the verticality and horizontality of the installed device using circular leveler.</p>  <p>As shown in the picture, use the Flat-head screwdriver to tighten BRAKE SCREWS.</p> <p>If the condition does not improve, do not attempt to repair. Please contact your supplier.</p>
3	If there is an error in the light pattern formation.	Inappropriate distance	Check if recommended distance(1m) between the LIGHTHEAD to the bed. If the condition does not improve, do not attempt to repair. Please contact your supplier.

4	If the SAFETY COVER of the LIGHTHEAD is polluted.	Pollution	Cleanse it with designated chemicals (Alcohol, Ethanol). If the essential performances of the device (Intensity of Illumination, Color Temperature) are seriously impaired, please contact your supplier.
---	---	-----------	--

<b>Internal Camera(optional)</b>			
<b>No.</b>	<b>Problem</b>	<b>Cause</b>	<b>Corrective action</b>
1	If the LED light on the LIGHTHEAD does not turn on.	Power cut	Check if supply mains are operating.
		Does not working of a backup power supply(BATTERY PACK or UPS).	Please contact your supplier.
		Others	Press the stand-by button of the control panel and check that the LED turns on. (If green light does not light on, do not attempt to repair it yourself, please contact your supplier)
2	Normal power supply, Power of the camera does not increase	Wrong connection of the power supply line (Power supply, Lighthouse power)	Please contact your supplier.
3	It is not output video	Video cable and HD-SDI convertor problem	Video cable check!! Please contact your supplier.
4	Camera control	Camera Controller problem	Please contact your supplier.
		Control B/D and the camera of the connecting line problem	Please contact your supplier.

## 11. Disposal









- For environment and safety of human, wastes must be recycled or separated.
- The materials should be carefully separated.
- The electrical boards should be submitted to an appropriate recycling proceeding
- The cardboard box may be recycled with other paper products.
- Please contact the closest DENTIS branch or your supplier, if you have any questions about recycling of the device.



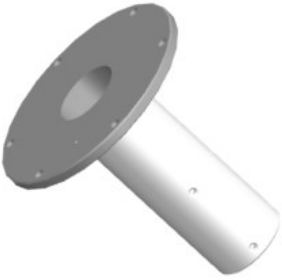

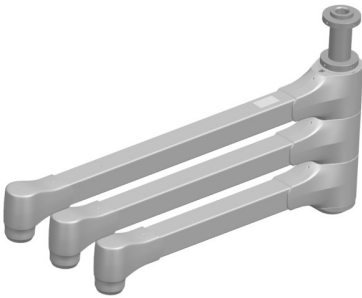
## 12. Model designation

- Model Reference

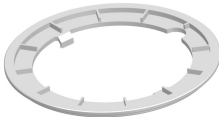
MAIN HEAD	HEAD_2	Head Arm Axis	Mount type	Spring Arm	Camera	Wall Controller	Battery
L200	N=None		S=Single Ceiling				
M200	A=L200		D=Dual ceiling	0=None	0=Without CAM		0=Without BAT
M210	B=M310	2=2Axis	T=Triple Ceiling	S= SA300	1=With Internal	0=Without WC	1=With BAT
M300	C=M300	3=3Axis	(with Monitor Arm)	V=VALIA	2=With External	1=With WC	
M310	D=M210		M=Mobile	A=ACROBAT	3=Ready		2=with BAT_2
	E=M200		H=Head Only				

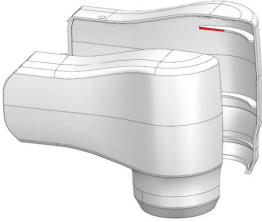
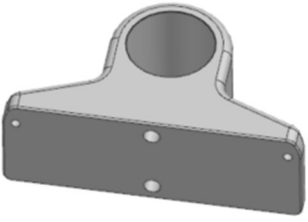
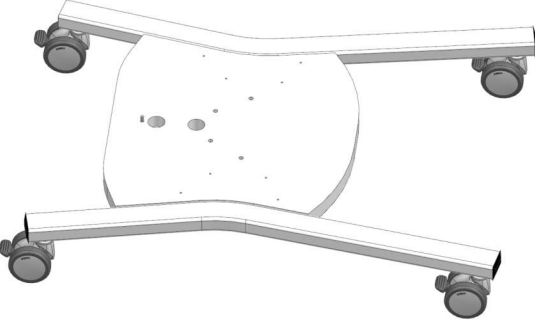
**13. List of component**

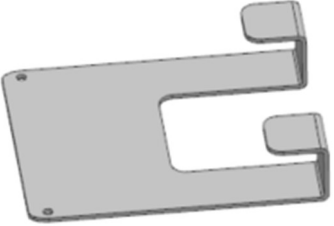
 <p>DROP TUBE(1WS)</p>	 <p>DROP TUBE(2WS)</p>
 <p>CENTRAL AXIS</p>	 <p>SPRING ARM(STD)</p>
 <p>SPRING ARM(LCH)</p>	 <p>CEILING COVER</p>
 <p>CA MIDDLE COVER</p>	 <p>CA MIDDLE COVER BTM</p>

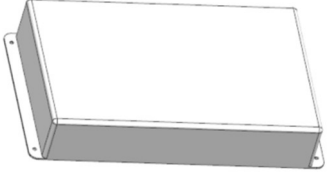
 <p>CENTRAL AXIS COVER L/R</p>	 <p>MOBILE BRACKET</p>
 <p>MOBILE BASE</p>	 <p>MOBILE BASE VERTICAL ARM(DOWN)</p>
 <p>MOBILE BASE VERTICAL ARM(UP)</p>	 <p>MOBILE HARNESS HOLDER</p>
 <p>MOBILE HARNESS HANDLE</p>	 <p>MOBILE SMPS COVER</p>

 <p>MOBILE HARNESS COVER</p>	 <p>SMPS</p>
 <p>BATTERY PACK(Optional)</p>	 <p>CAMERA(Optional)</p>
 <p>L200 LIGHTHEAD(2Axis)</p>	 <p>L200 LIGHTHEAD(3Axis)</p>
 <p>WALL CONTROL BOX (Optional)</p>	

### 14. Manufacturer and Factory

- Manufacturer, Factory : DENTIS MEDICAL DIVISION  
6, Yuram-ro, Dong-gu, Daegu, Republic of Korea

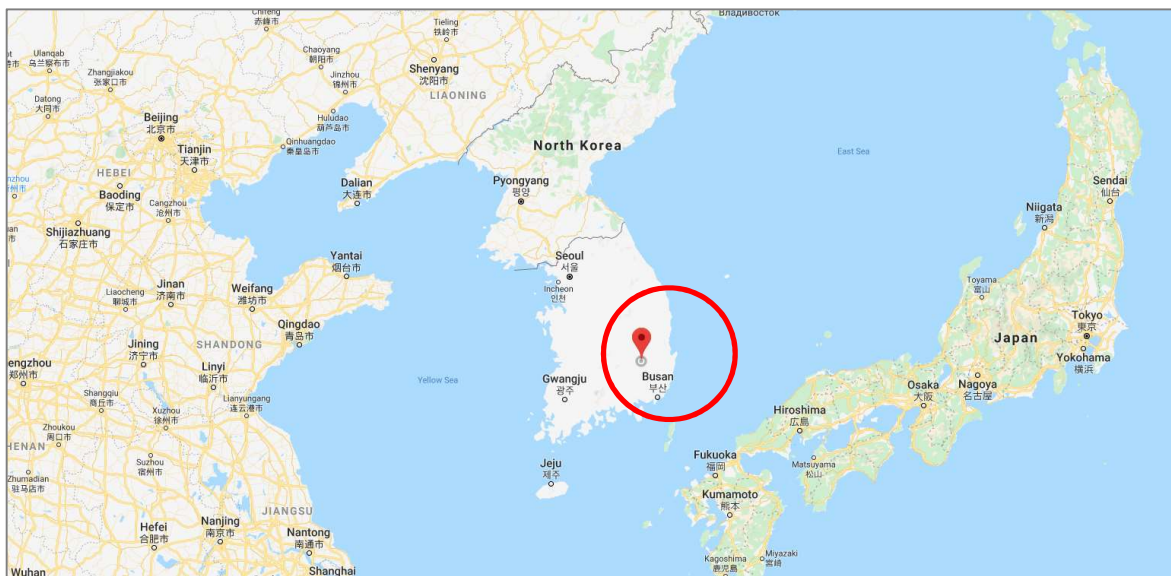
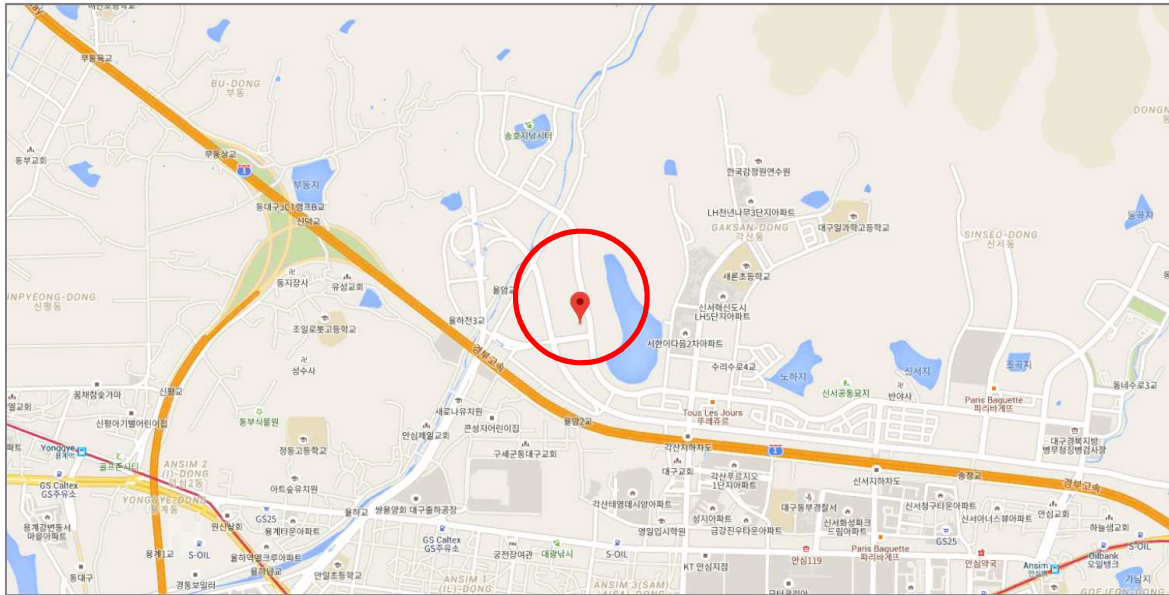

Professional LED Surgical Luminaire for All of Surgery Application

## 15. Europe Representative

- Location of EC REP  
KTR Europe GmbH  
Address : Mergenthalerallee 77, 65760 Eschborn, Germany

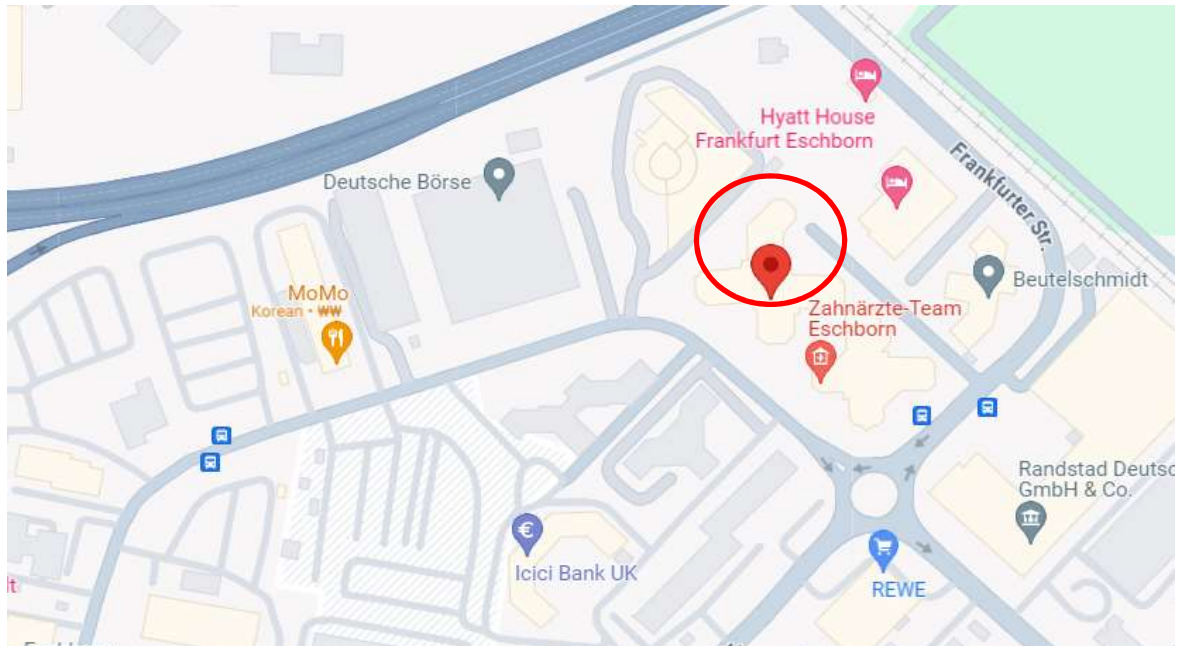

EL2LEP-PM030  
(V2.11) Nov/01/2024  
USR-L2-02



[www.luvis.co.kr](http://www.luvis.co.kr)



---

**DENTIS Co., Ltd. (HEADQUARTERS)** 87, Yuram-ro Dong-gu, Daegu, Republic of KOREA Tel +82-53-583-2804 Fax +82-53-583-2806  
**DENTIS MEDICAL DIVISION(FACTORY)** 6, Yuram-ro, Dong-gu, Daegu, Korea Tel. +82-70-7730-4146 Email. [luvis@luvis.co.kr](mailto:luvis@luvis.co.kr)